

PNEUMATIC SYSTEMS

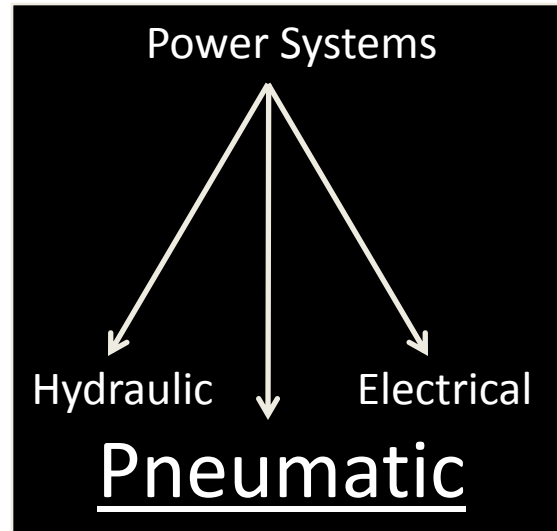

Aircraft Pneumatic Systems



Aircraft Pneumatic Systems power Instruments, landing gear, flaps, air conditioning, windows, doors and more

Aircraft Pneumatic Systems

- Sometimes called vacuum pressure systems
- Similar to hydraulic system but with air instead of fluid
 - Difference
 - Air is compressible
 - Fluid is not compressible
- In light Aircraft, Suction Pressure Gauge shows Vacuum System Pressure

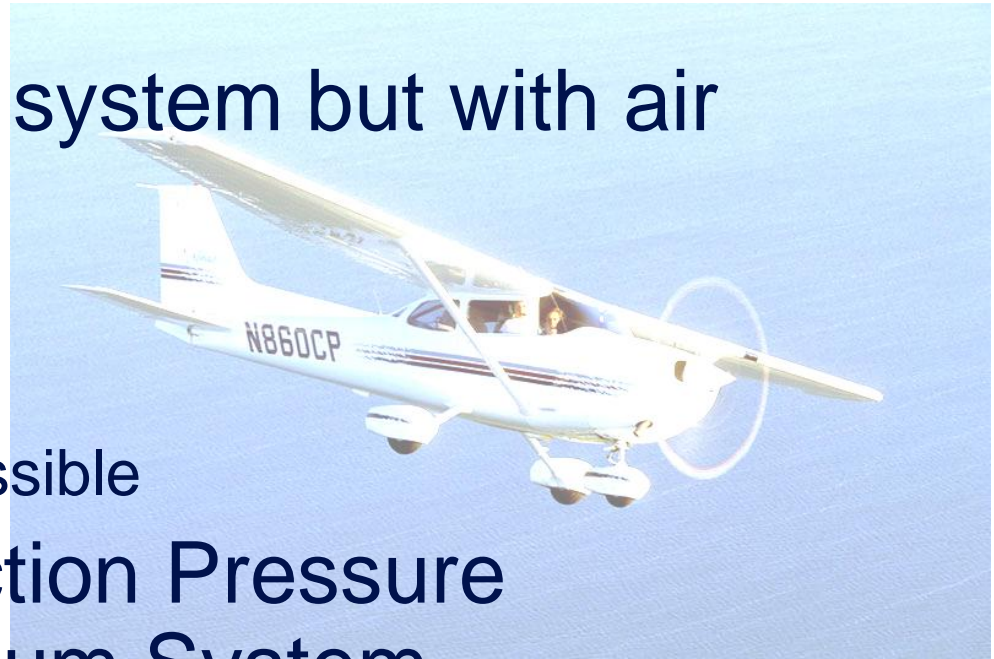

Vacuum Systems

- Pumps
- Relief Valves
- Vacuum Manifold
- Vacuum Air Filter
- Suction Gauge

Gyro instruments:

- Attitude Indicator
- Heading Indicator



On Off Valve in the Off Position

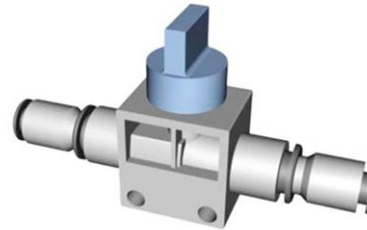

Note the arrow on the valve body.
This indicates the direction of the air flow through
Through the valve

Pressure Adjustment Knob

Pull the knob out to adjust the pressure.

Raise pressure by screwing the knob inward (CW)

Lower the pressure by screwing the knob out (CCW)

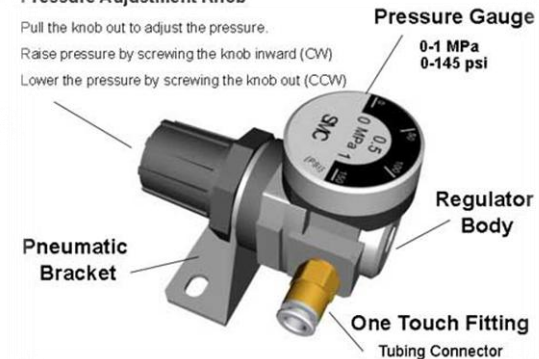

Advantages of Pneumatics

- Simple
- Reliable
- Light weight
- Safe
 - (if properly maintained)

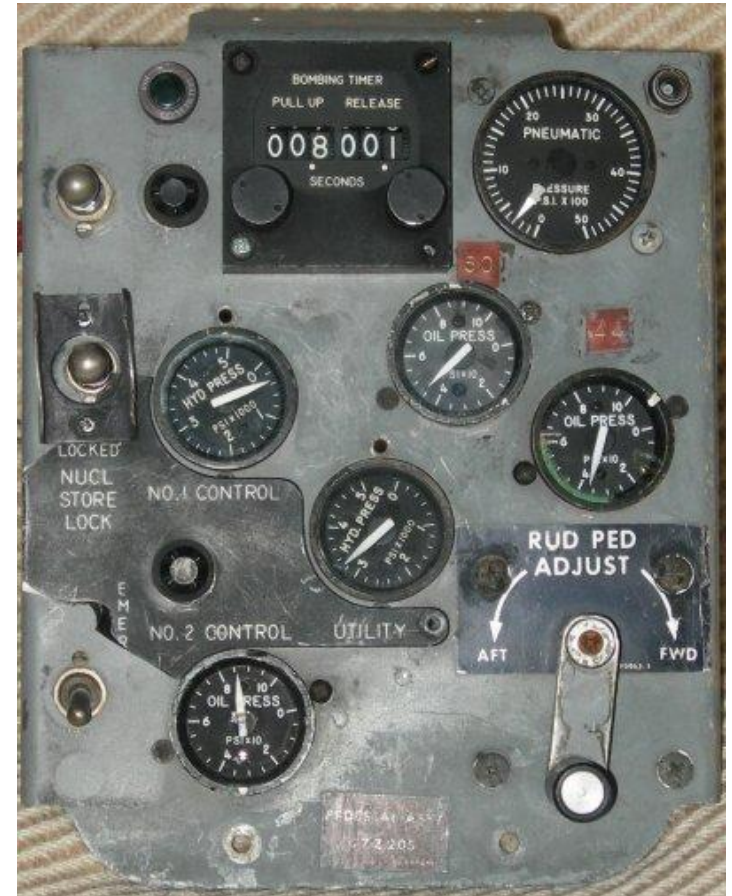

Pneumatics Use in Small Aircraft



Pneumatic System Components

Pneumatic systems in GA aircraft are pretty straightforward:

- Air Pump
- Vacuum Regulator
- Inlet Air Filter
- Overboard Vent Line
- Gauges:
 - Attitude Indicator
 - Heading Indicator
- System Indicators
 - Suction Gauge
 - Gyro Flag
 - Annunciator Lights (AL)
 - Not all aircraft have ALs

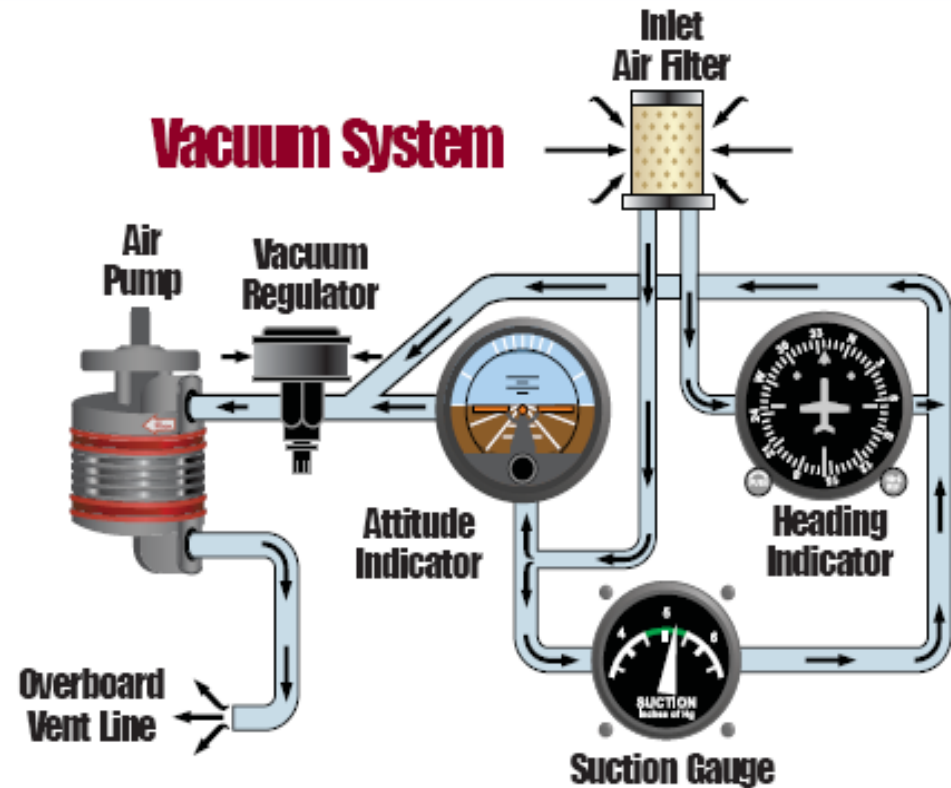

How Pneumatic Systems Works

- Filtered Air is pulled through system by vacuum pump
- Evacuated air passes through instrument case causes gyro to spin
- Spinning gyros provide “rigidity in space” for instrument references
- Air exhausts through Gyro Pressure Gauge exhaust port
 - Gauge measures system pressure
- Failure Warning Systems

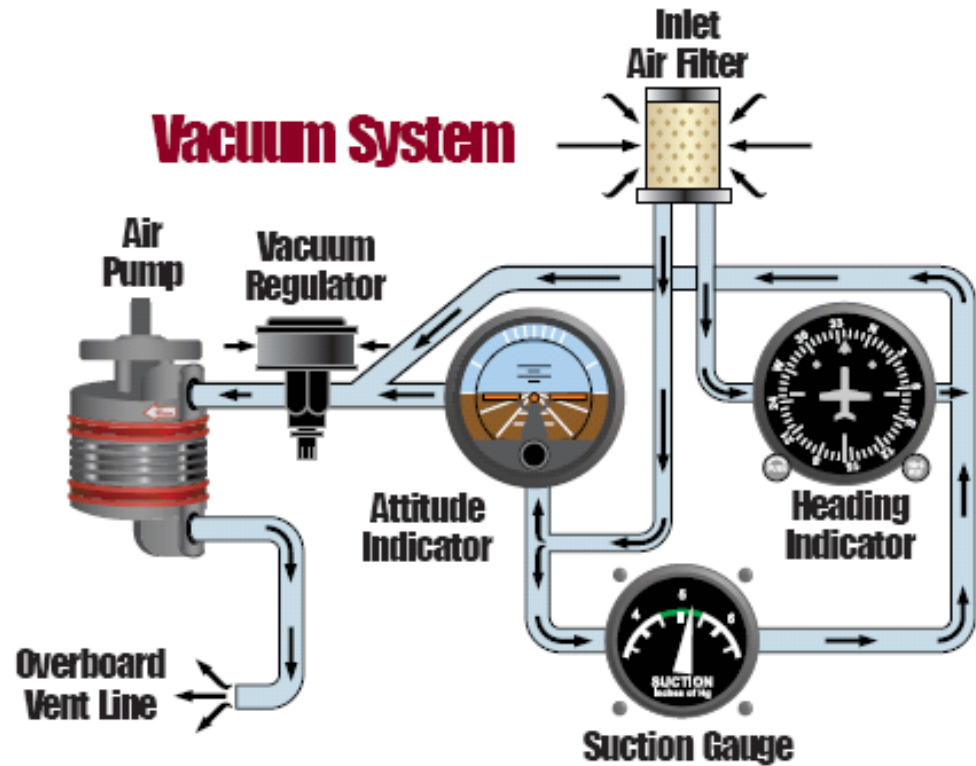

Pneumatic Air Filter

- Prevent system contamination
- Remove air particulates
- Clean air is essential to good operation



Pneumatic Pressure Regulator

- Prevents system over pressurization
- Insures proper calibration



Air Pump

Heart of pneumatic system is **pressure or vacuum air pump**
(Usually engine driven)

- Two basic types :
 - **Wet air pumps** use engine oil to lubricate pump internally
 - **Dry air pumps** - more common –have graphite vanes inside pump casing - self-lubricate as pump rotates



GA Aircraft Instrument Panel



Attitude and Heading Indicators



Signs of Pneumatic System Failure

- Inaccurate/conflicting Instrument information
- Suction/pressure gauge indicates outside normal operating (green) range

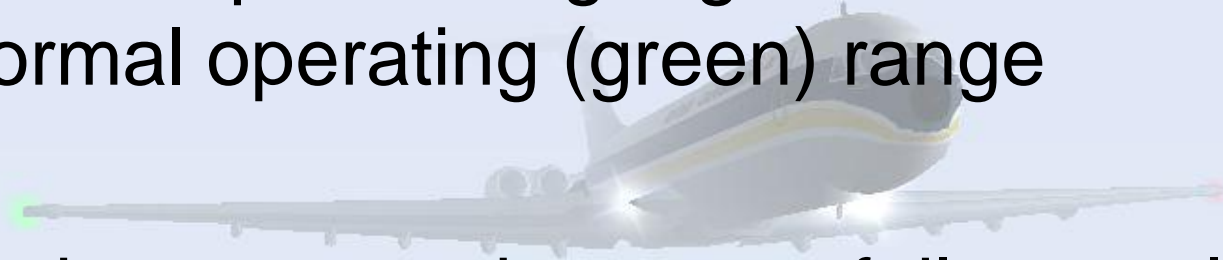

Spotting pneumatic system failure early
reduces chances of spatial disorientation

Causes of Pneumatic System Failure

- Contamination:
 - Solid particles in pneumatic system damage pump and plug valve openings
 - Liquids from oil, water, or engine cleaning solvents
- A loose fitting or damaged hoses
- Worn out, misused, or incorrectly routed hoses
- Abrupt engine deceleration
- Sudden engine stoppage



To Avoid Spatial Disorientation

- Install a backup power supply for pneumatics
- Regularly check suction gauge in instrument scan
- Maintain proficiency in “partial panel” instrument flying
 - Cover up or simulate loss of flight instruments
- Make timed turns
- Notify ATC, declare an Emergency
- In IMC – seek and fly to VMC
- Ask ATC for “no gyro vectors (and approach)”
- Use a precision instrument approach, if available and favorable to your situation



Elements of a Basic Compressed Air Pneumatic System

- A. Air Compressor
- B. Check Valve
- C. Accumulator
- D. Directional Valve
- E. Actuator

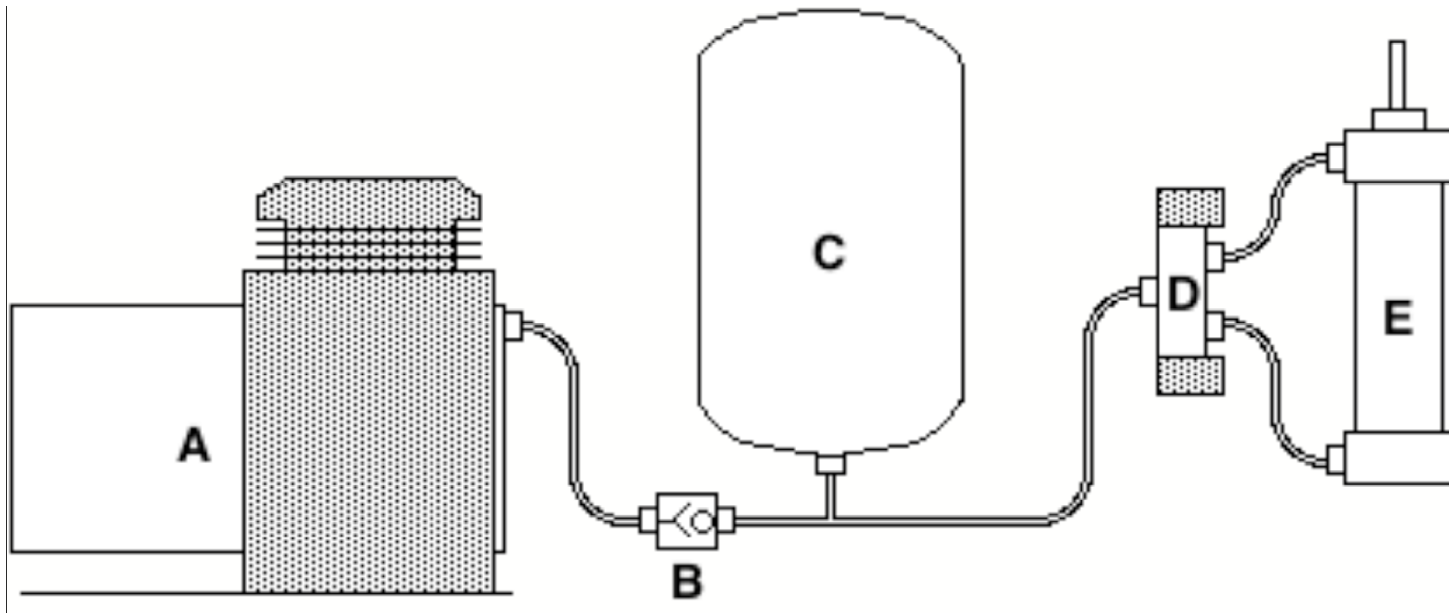

A – Compressor

- Pump that compresses air, raising air pressure to above ambient pressure for use in pneumatic systems

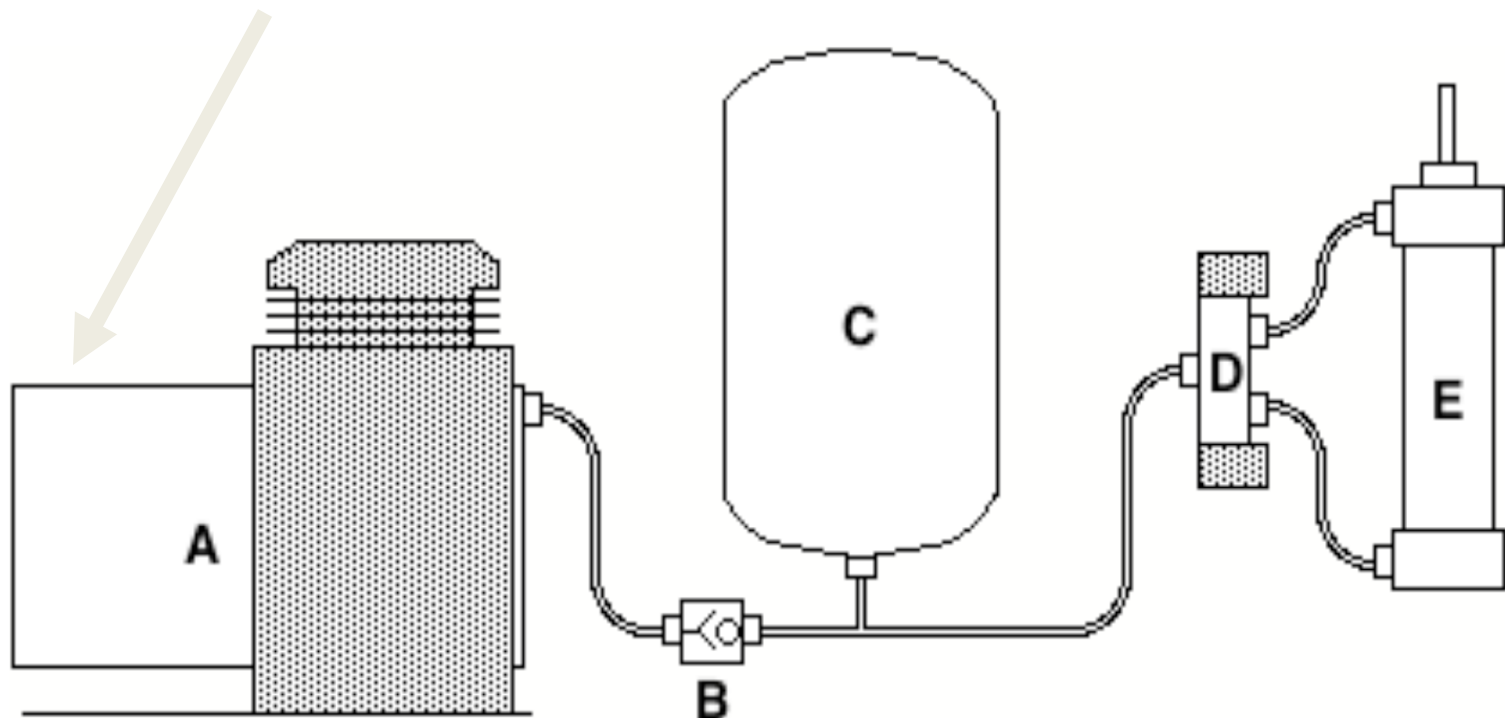

B – Check valve

- One-way valve - allows pressurized air to enter the pneumatic system, but prevents backflow of air toward the Compressor when Compressor is stopped (prevent loss of pressure)

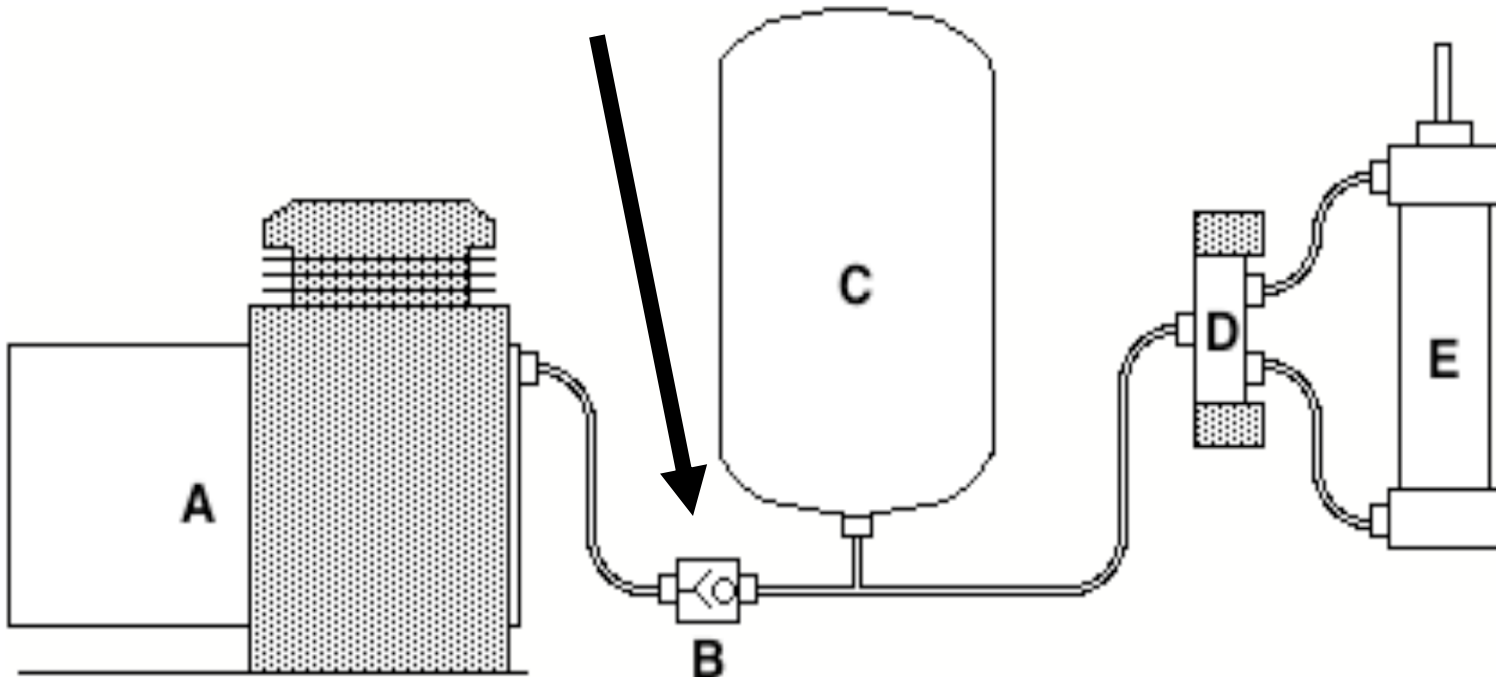

C – Accumulator

- Stores compressed air,
- Prevents surges in pressure
- Prevents constant Compressor operation (“duty cycles” of Compressor)

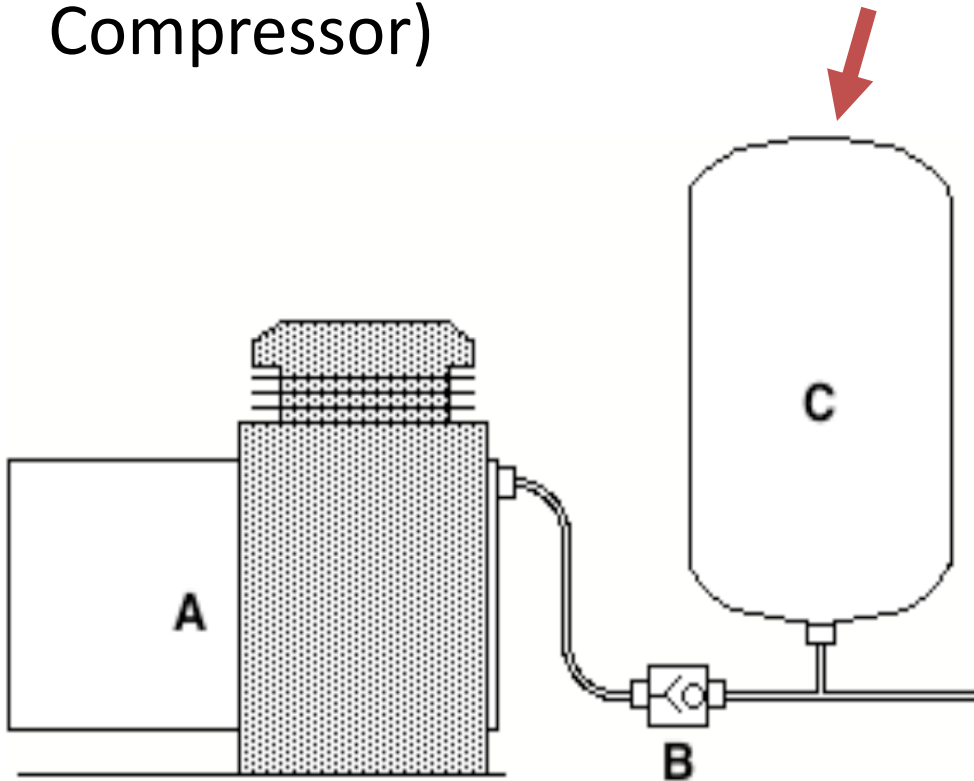

D – Directional valve

- Controls pressurized air flow from Accumulator (source to user equipment via selected port
- Some valves are one way – shut tight
- Some valves are two way, allowing free exhaust from the port not selected
 - valves can be actuated manually or electrically

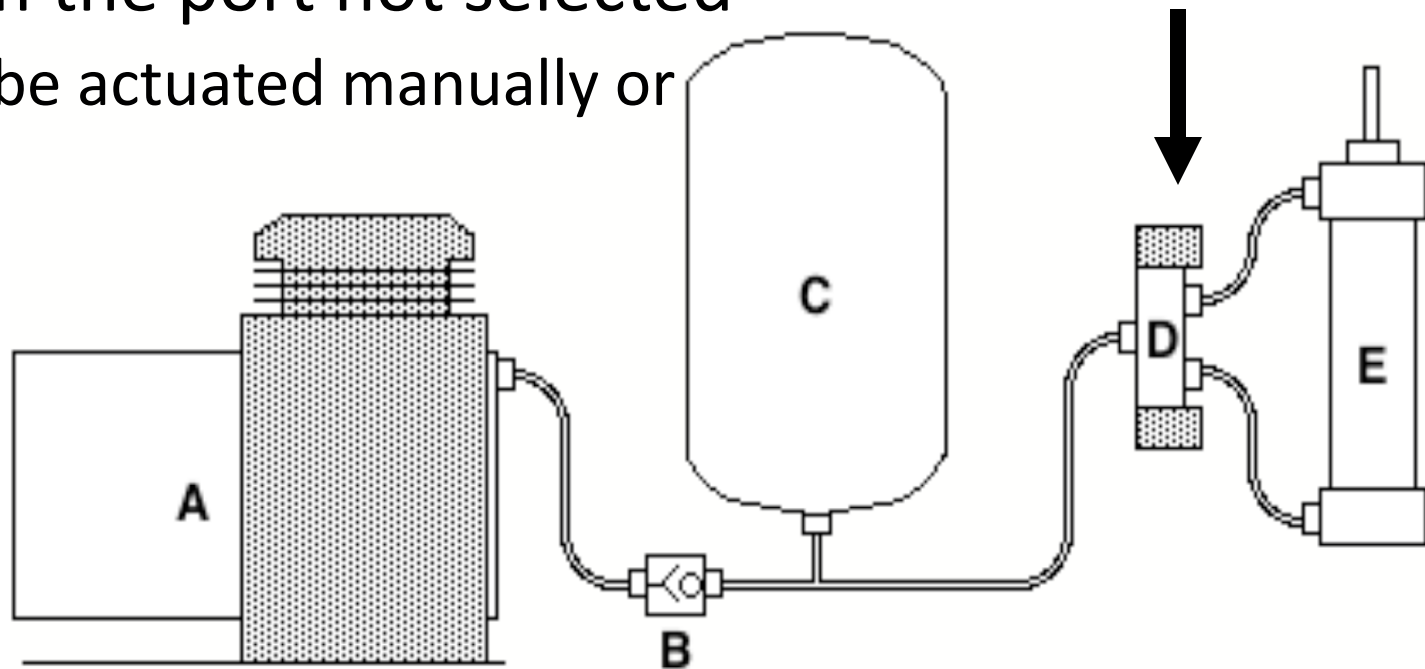

E – Actuator

- Converts energy stored in compressed air into mechanical motion
- Example is a linear piston (piston limited to moving in two opposing directions)
- Other examples are alternate tools including: rotary actuators, air tools, expanding bladders, etc

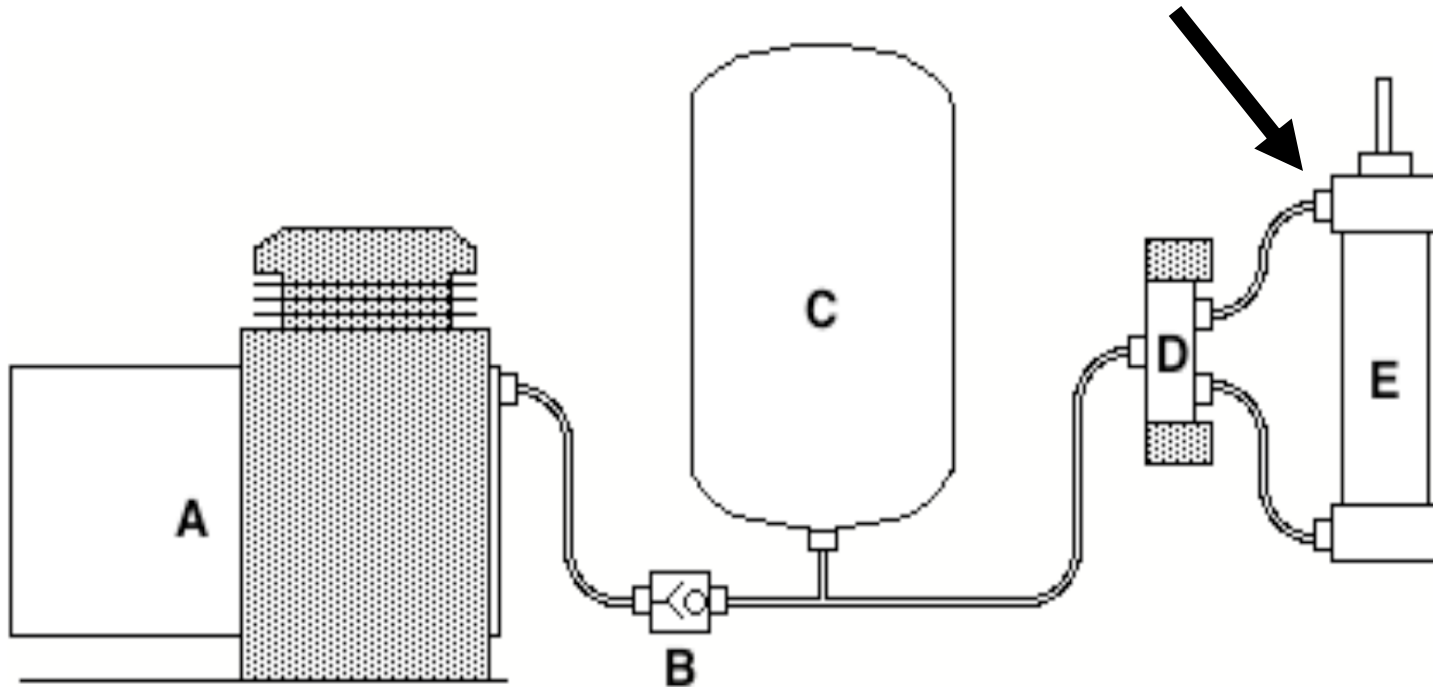

Pneumatic uses in Aircraft

- Powers engine Suction System for
 - Heading indicators
 - Attitude indicators
- Actuates Landing Gear (some aircraft)
- Emergency Brakes (some aircraft)
- Cabin Pressure (for pressurized aircraft)



Pressure Pump Types

- Two basic types: wet and dry
 - Wet air pumps use engine oil to lubricate inside of pump
 - Dry Air pumps - more common - have graphite vanes inside pump housing which self-lubricate as vane rotates



Pressure Pumps

Heart of Pneumatics System

- Power Aircraft Flight Instruments using:
 - Positive-Pressure Pump
 - Increases air pressure, or
 - Vacuum (negative pressure) Pump
 - Decreases air pressure
 - Both are usually engine-gear driven air pumps
- Air pump draws air into the system through a filter
- Fast-moving stream of air passes over rotating vanes within heading and attitude indicator gyroscopes, causing the gyroscopes to rotate at about 10,000 RPM. Creating “rigidity in space”

Pneumatic Actuator

- Converts Energy into Motion

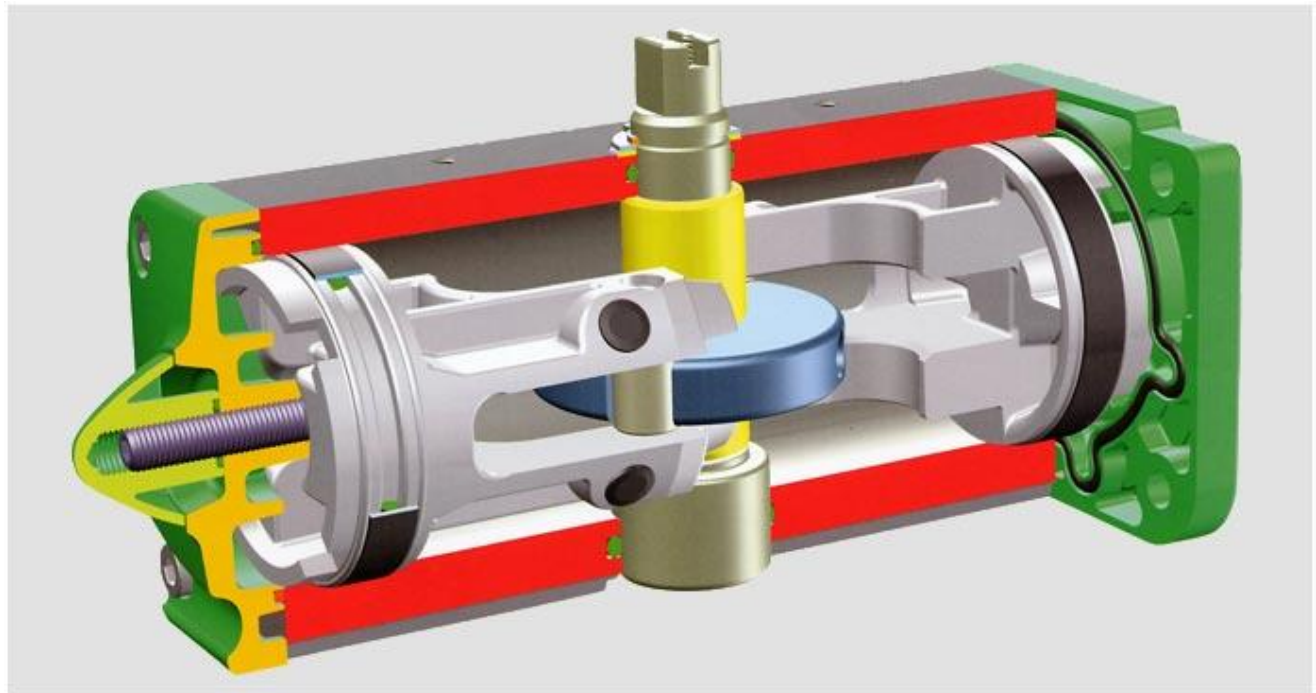

High Pressure Air Systems

- Operate wing flaps, brakes, and landing gear.
- Hydraulic or actuating systems also operate these units.
- Pneumatic system also powers autopilot and de-ice systems.
- Reminder - Pneumatics are similar to hydraulics, except pneumatics use air rather than fluid for the actuation of mechanical units.
- One disadvantage of pneumatics is the air is compressible, unlike fluid in hydraulics, so pressure variability can be a problem.

Pneumatic Safety Systems

- Pressure to blow down and lock down gear in event of normal gear extension (hydraulic) failure



Deicing Boot

- Installed on Wings and Control Surfaces
- Made of Thick Rubber Membrane
- Inflates with Compressed Air

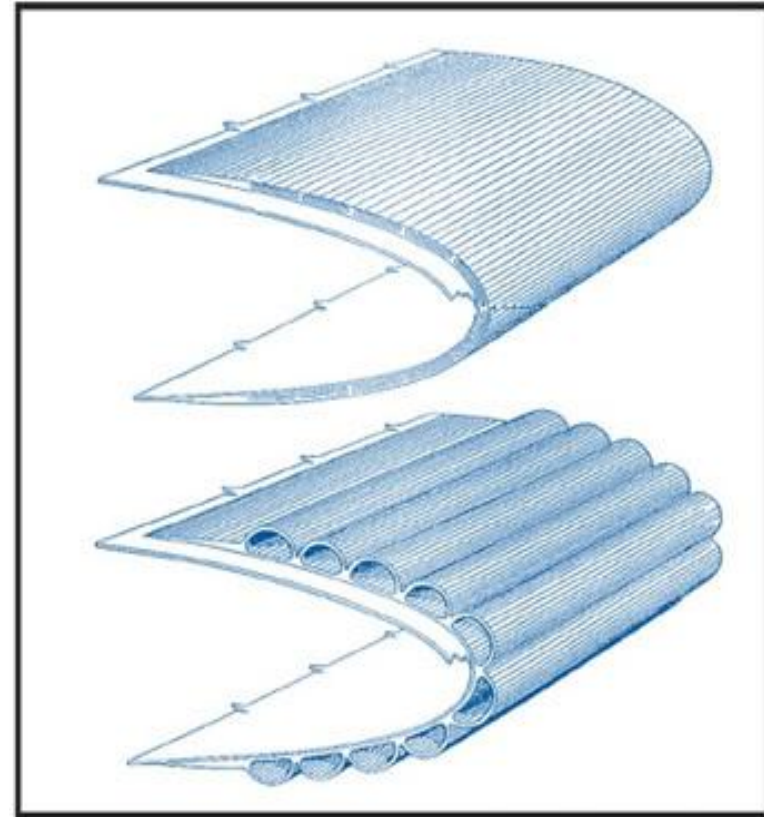

Goodrich pneumatic boots

Pneumatics in Flying Surfaces (Wings and Empennage)

- Up to 15,000 psi
- Pyrotechnic and mechanical activation
- Variable damping and rate deployment
- **Pneumatic Wing and Tail Actuators**



Air Brakes



- Reduce Speed During Landing
- Increase Drag
- Little Effect on Lift

Pneumatic systems – Other uses

Waveguide

Pneumatic safety systems are component systems in many aircraft



- **Waveguide Pressurization System**
Delivers dry nitrogen
- Prevents Arcing in Radar Waveguide
- Fully automated system
- Used in High Performance Aircraft - F16 and F15E

Advantages of Pneumatic Systems

- Light weight
- Safe
- Reliable
- Eco-friendly
- Small (can be)
- Unaffected by atmospheric changes
- Inexpensive components
- Pressure seals are usually problem free
- Forces transmitted are easy to manage (within acceptable PSI limits)

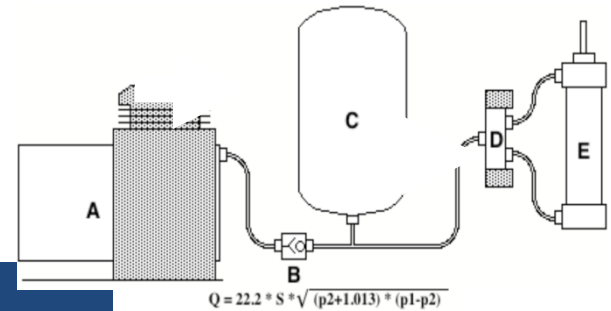

Bottom Line - Safety

Recognize Eminent
System Failure

-Take action

Signs of Failure

- Gauges
- Warning Systems
- Aircraft handling





Eject

Eject

When everything else goes wrong!

The most important pneumatic system for
pilot survival!!!

Eject



THE END
FLY SAFE!!

References

http://www.tpub.com/content/aviation/14014/img/14014_93_1.jpg

<http://www.robotstoreuk.com/ACTUATORS/AIR-MUSCLE/AIR-Muscle-IMAGES/Basic-air-system-350.jpg>

http://www.airportbusiness.com/images/article/1154550280769_DOW.jpg

<http://greggordon.org/images/pitotStaticSystem.jpg>

<http://books.google.com/books?id=A0buKXqCcUMC&pg=PA287&lpg=PA287&dq=pneumatic+system+aircraft&source=web&ots=YwVrW63vnu&sig=ayKt1S2YoCQ689T9yg4NUHludYw#PPA283,M1>

<http://ranier.oact.hq.nasa.gov/team116/2003/lessons/Lesson7-Pneumatics.pdf>

<http://www.aopa.org/asf/publications/SB06.pdf>

http://www.nfpa.com/Education/Edu_LearningOpps_SelfPacedFundamentalsPneumatic.asp

Pneumatics

Pneumatics-Pertaining to or operated by air or gas—
Mcgraw Hill, 2nd ed.,Dictionary of Engineering

Pneumatics are compressed air directed at auxillary functions;ie.de-icing equip.The basic composition of all compressed gas systems include a compressor pump (or vac),a resevoir tank(enables capacity storage on demand supply),a pressure regulator,directional proportional valves,hi press. Air lines,and end use component or tool.

Pneumatics cont.

- Pneumatics are used to operate systems & equipment from remote locations (ie. Inside wings, or external hatches) pneumatics are lightweight, compact, sturdy and easily maintained. The principle operation of an aircraft's speed indicator, turn ind., & gyros to name a few—are pneumatic controlled. My main theory of this paper is to point out the turbo-charger system as a thermo-pneumatic, jet pro-impelled dual dynamic system. The induction air is ram fed to the intake via a compressor, and the waste exhaust is redirected to a turbine impeller on the reverse end of the compressor's shaft; which combines the use of compressed hot & cold gases to overcome thinner air at increased altitude and speeds. That is also thermo-dynamics. The use of both ends of the compressor as forced air induction and forced heat exhaust through the turbine is the basis of jet propulsion—although actually impelled @ a right angle rather than straight through as typical jet engine. Now add the cabin pressure system using compressed air and constant pressure adjustable relief valve—and you get 8000 ft pressure at 24000 ft. Flying above the weather and riding favorable winds making good time.

Air Pump Functionality

1. The air pump draws air into the system through a filter
2. The fast-moving stream of air passes over the vanes within the heading and attitude indicator gyros, causing the gyroscopes to rotate at about 10,000 RPM
3. In many aircraft, the same air pump powers the autopilot and de-ice systems

System Failure Alerts

Pneumatic System health can be determined by the indications on either the vacuum gauge or flags on the attitude indicator



Annunciators and flags provide an early indication of a pneumatic system failure.

Compressor System

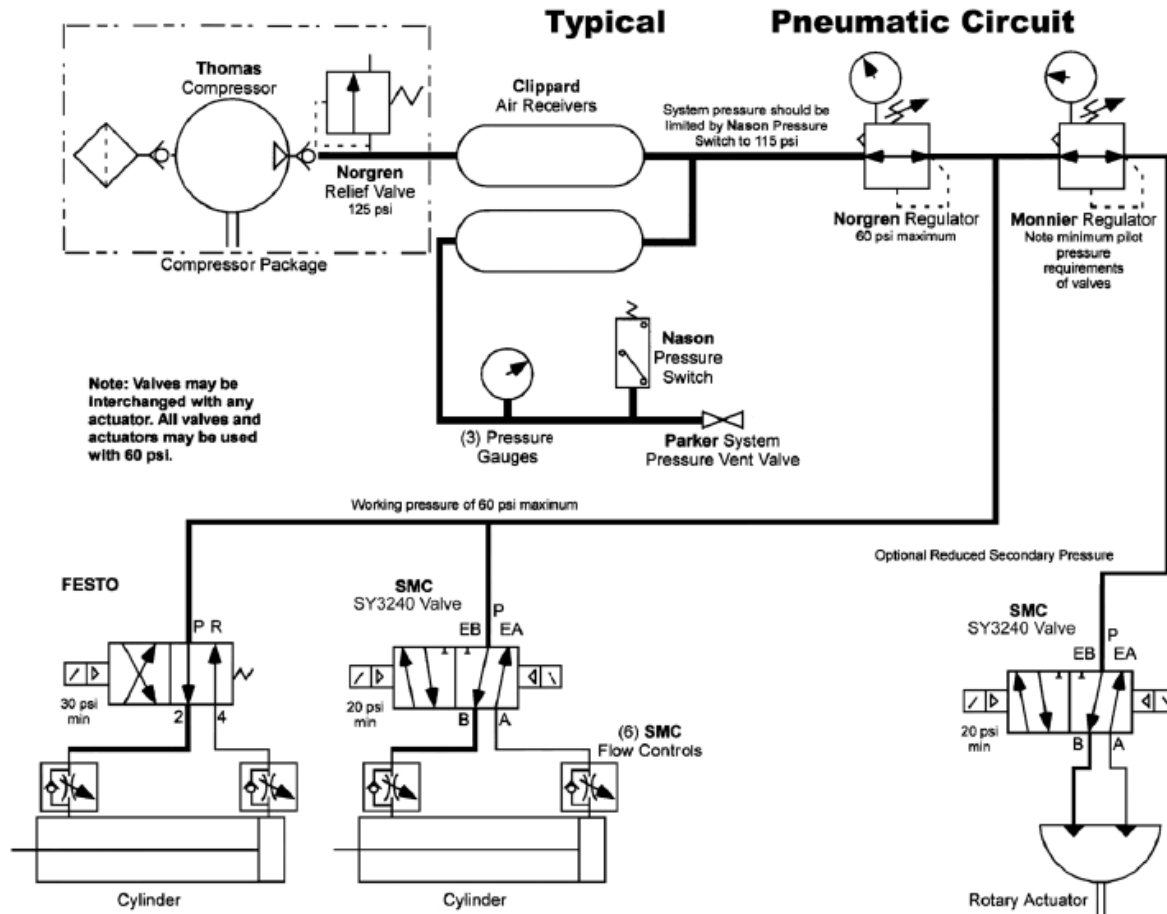

Typical Components

- Compressor pump
- Accumulator tank
- Check valve
- Directional valve
- Actuator
- Relief valve
- Pressure gauge

Vacuum System

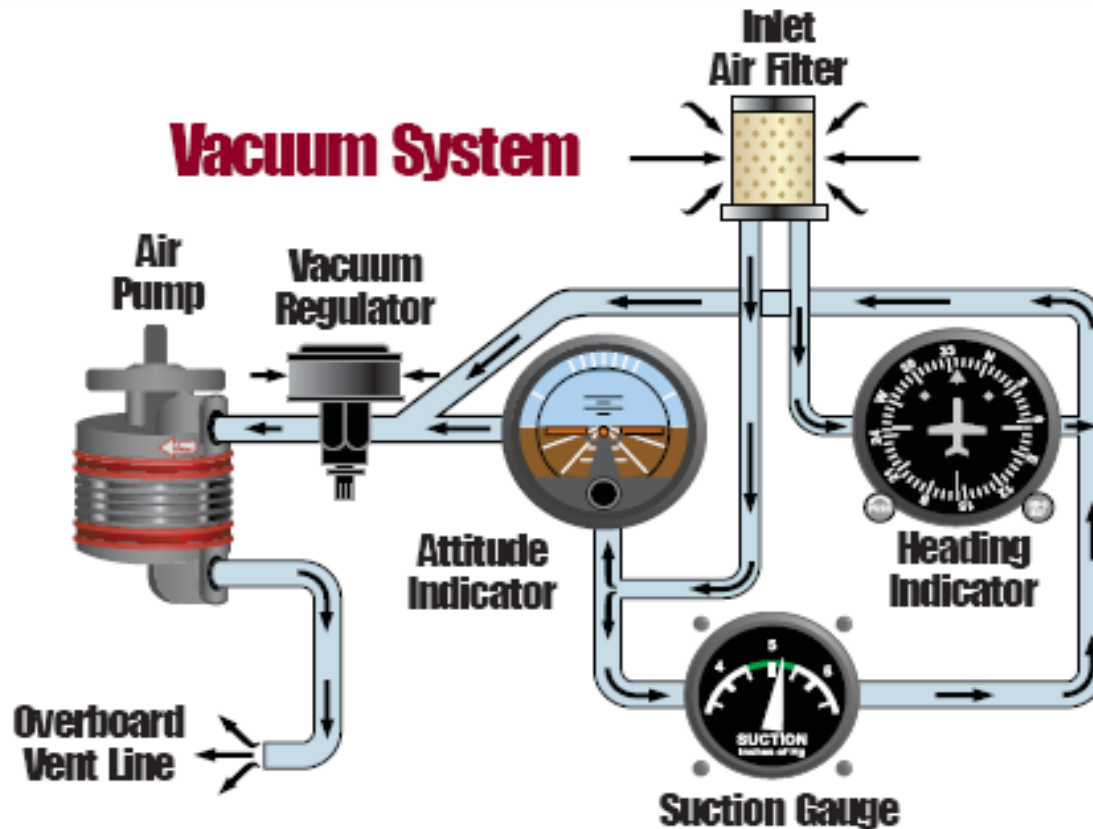

The heading and attitude indicators in many GA aircraft are powered by the pneumatic system.

Typical Components

- Air inlet filter
- Instruments
- Vacuum regulator
- Air pump
- Overboard vent line

Other Uses in Aviation

- Wing de-icing equipment
- Manufacturing / maintenance
 - Power tools

Warning!

- The attitude indicator is the most important flight instrument; wing icing is potentially fatal.
- Good maintenance will generally ensure the pneumatic system will be reliable when you need it the most!

Pneumatic Systems

Advantages:

- Less Weight.
- No fire hazard.
- A clean system (no fluid).
- No requirement to return air to a reservoir.
- Known as vacuum or pressure systems.
- Driven by two types of air pumps, wet and dry.
- Wet air pumps use engine oil to lubricate the pump, dry pumps have vanes inside the pump that self-lubricate as they rotate.

AIRCRAFT PNEUMATIC SYSTEMS

Corey Hjalseth
Ali Spriggs



Pneumatic System

A.K.A. Vacuum System

- Only certain flight instruments are powered by the vacuum system.
- The vacuum pump is mounted on the rear of the engine.
- The air pump is engine driven.
- The pump draws in the air through a filter.
- The air moves over the gyros for the heading and attitude indicator.
- The air causes the gyroscopes to move at 10,000 RPM.
- The air goes out through the vacuum regulator.
- The air finishes its trip by passing through the air pump and overboard vent line.

PNEUMATIC SYSTEMS DIAGRAM

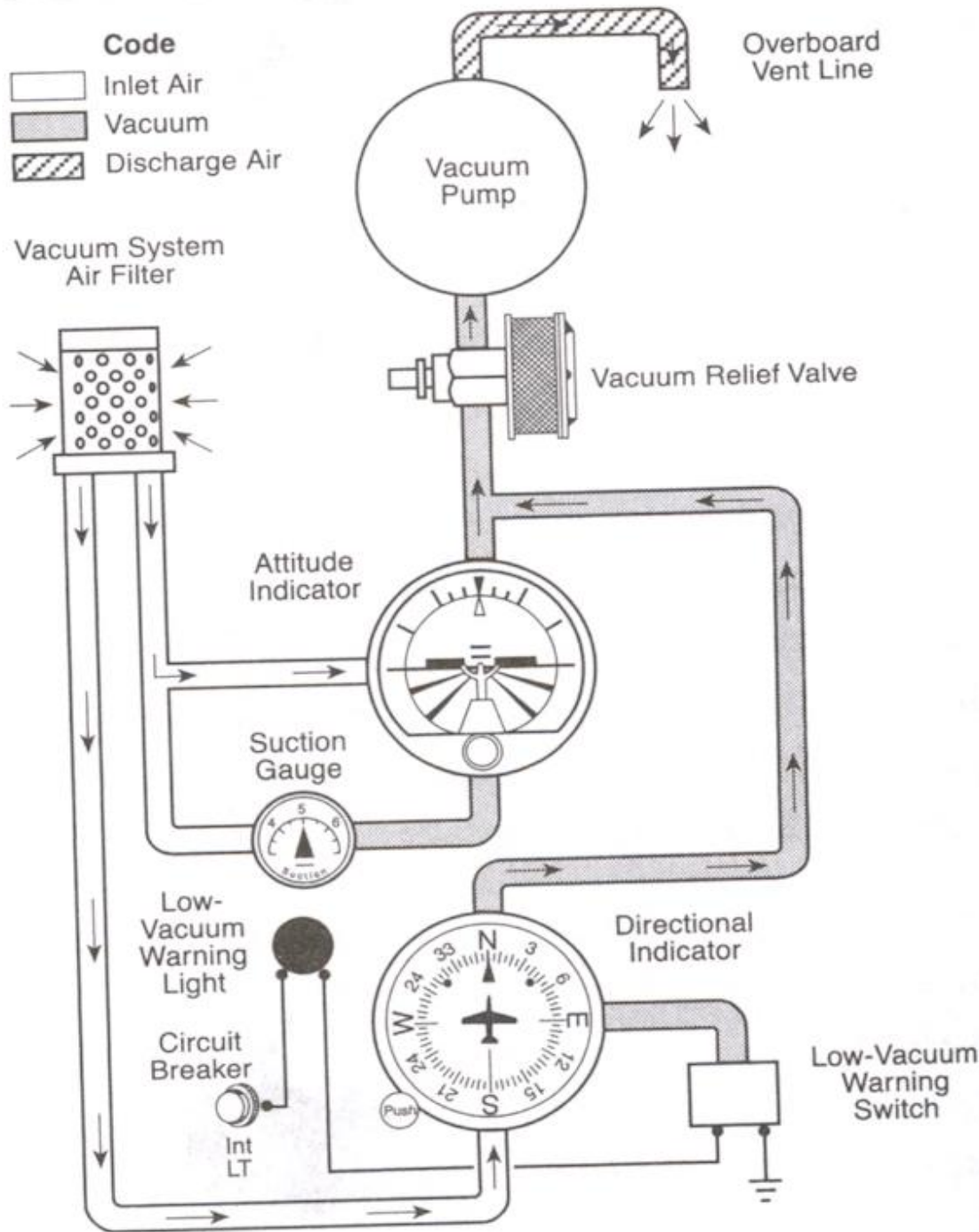

TYPES OF PUMPS

- There are two kinds of pumps. Wet and dry.
- Wet pumps use engine oil for lubrication.
- Dry air pumps are more common than wet.
- Dry pumps have graphite vanes which lubricate as they rotate.
- The pumps effectiveness is measured by a suction gauge on the instrument panel.
- These pumps power the Heading and Attitude Indicators.